



## **PLOTWAVE 3000/3500 PRINTING SYSTEMS**

Easy, Secure, and Intelligent Large Format Technical Document Management  
*4/6 D-size per minute, 1-2 rolls*

**SMART CHANGE STARTS HERE.**



PlotWave 3000/3500  
printing systems



PRINTER ONLY



MULTIFUNCTION WITH  
OPTIONAL STACKER

## PLOTWAVE 3000/3500 PRINTING SYSTEMS

### Flexible technical document management for professionals

- Printer only or multifunction (print/copy/scan) system with integrated scanner
- Integrated Top Delivery Tray (neatly collates and stacks up to 100 E-size plots)
- ClearConnect walk-up interface (intuitive touchscreen control)
- Cloud-integrated workflow option (scan to/print from cloud)
- Proven core technologies from Canon help to deliver superior productivity
- Single or optional dual roll media capability (up to 650 feet per roll)

### NEW FEATURES!

- Faster POWERsync Controller hardware (avg. 30 percent faster CPU vs. predecessor)
- Microsoft Windows 10 LTSC IoT Enterprise (controller OS)
- New set of Security Features
- Standardized security features, including AES 256 data encryption, secure boot, and Access Management user authentication enabled
- Optional McAfee Application control (whitelisting)
- ENERGY STAR® 3.0 compliant
- New cabinet colors (Titanium White with Damson Black trim)

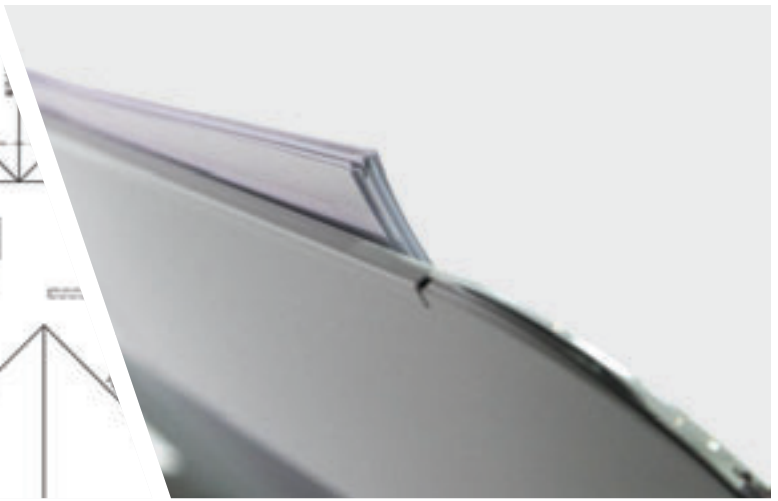
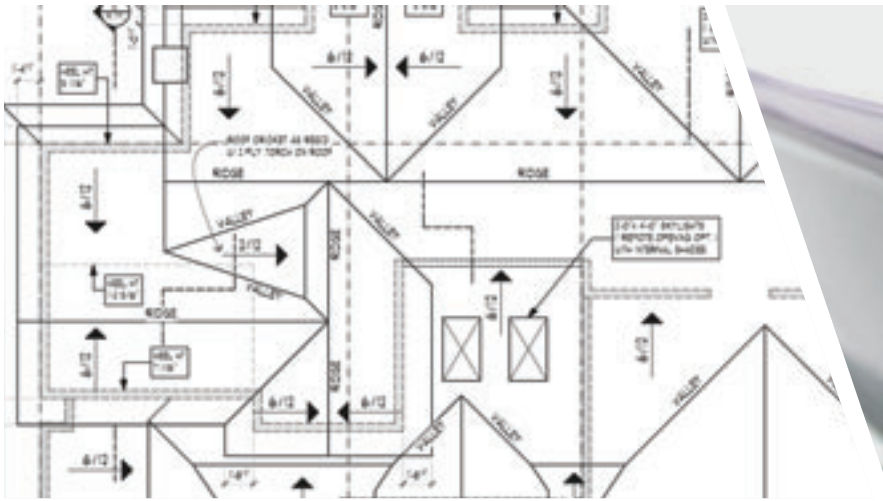

# EASY

## PlotWave Series

### EASY, SECURE, AND INTELLIGENT

For complex technical document print jobs, it is important that your printer produces impressive results every time. Designed for CAD professionals, the PlotWave series makes printing large format documents easy with its intuitive touchscreen interface. Intelligent automation utilizes the power under the hood and tunes it to support high performance. Robust security features help safeguard your data. With its small footprint, ergonomics, and clean, closed toner system, a PlotWave series technical document printer is an excellent fit in busy departmental or workgroup environments.

### EASY, SMOOTH OPERATION AND WORKFLOWS

PlotWave series printers are easy to use thanks to embedded intelligence and exceptional simplicity. Access and print your latest revisions from your home folder, cloud, or local network, or use the intuitive copying and scanning features available on the walk-up touchscreen interface.

The PlotWave series enables you to print only the files in your own inbox, which is essential for project groups. Virtually no warm-up time means users can quickly print and collect their own confidential documents.

### CLEARCONNECT SOFTWARE SUITE: COMPLEX JOBS MADE EASY

With ClearConnect, even the most complex jobs and technical document sets become easy to print. Drag and drop files for great results. Accurate, live print previews enable you to check the effect of your print settings immediately. This supports peace of mind and helps avoid costly, time-wasting misprints. Standardize your workflow and efficiently repeat jobs with easy-to-create scan templates.



### PRINT FROM ANYWHERE? EASY!

Printing from many locations and sources is supported by the PlotWave series. With Publisher Mobile, you can preview and print files from your mobile phone or tablet. With Publisher Express, you can submit print files directly from the web. Driver Select, the printer driver for Windows, helps reduce errors and supports first-time-right results, with its clear and easy-to-use functionality. Driver Express enables printing PostScript files from Mac and Windows.



PlotWave 3000 series



PlotWave 5000 series



PlotWave 7500

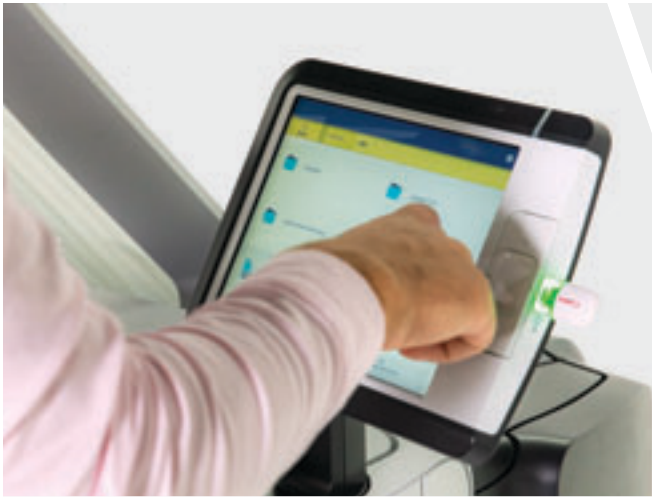

# SECURE

## PlotWave Series

### SECURE ON ALL LEVELS

Security is critical in today's office environment. Your data, your working environment, and your results are in safe hands with the PlotWave series.

### NEW SECURITY FEATURES HELP PROTECT YOUR DATA

Data protection is provided in each phase of the print process. When the data is in transit, it is protected by secure, encrypted protocols. When at rest, your data is encrypted.

Since a printer is typically not used as a long-term data storage solution, data shredding and proper deleting protocols help make deletion secure. There is also an option for a removable hard drive. Robust user authentication helps provide document security for users and activity control for budget managers. Hack prevention helps guard against malicious intrusion. All of these security measures have been built with the long term in mind.



### SAFEGUARD YOUR PROFESSIONAL RESULTS

The PlotWave series is designed for first-time-right printing. It helps users avoid costly misprints, while saving time, paper, and toner. Radiant Fusing technology prevents print resolution loss, dot size degradation, and line fuzziness since the toner melts exactly where it is placed on the media. Achieve professional results with the integrated Scanner Express: Image Logic boosts readable details in the scanned file by helping to reduce creases and paper folds in the scanned original.

### MAINTAIN A HEALTHY OFFICE AND SUSTAINABLE ENVIRONMENT

The PlotWave series is a good office companion. With low noise levels and low heat emissions, they are perfect for in-office environments. The toner system is completely closed.

The ClearConnect user interface tilts and swivels for ergonomic comfort. In addition, the PlotWave series is environmentally friendly. Radiant Fusing technology helps to ensure low power consumption, and the system is ENERGY STAR®-certified.

### HELP SECURE YOUR PRODUCTIVITY

The PlotWave series is built to help withstand intensive use and safeguard your productivity. The POWERsync controller is based on Windows 10 IoT OS for long-term support.

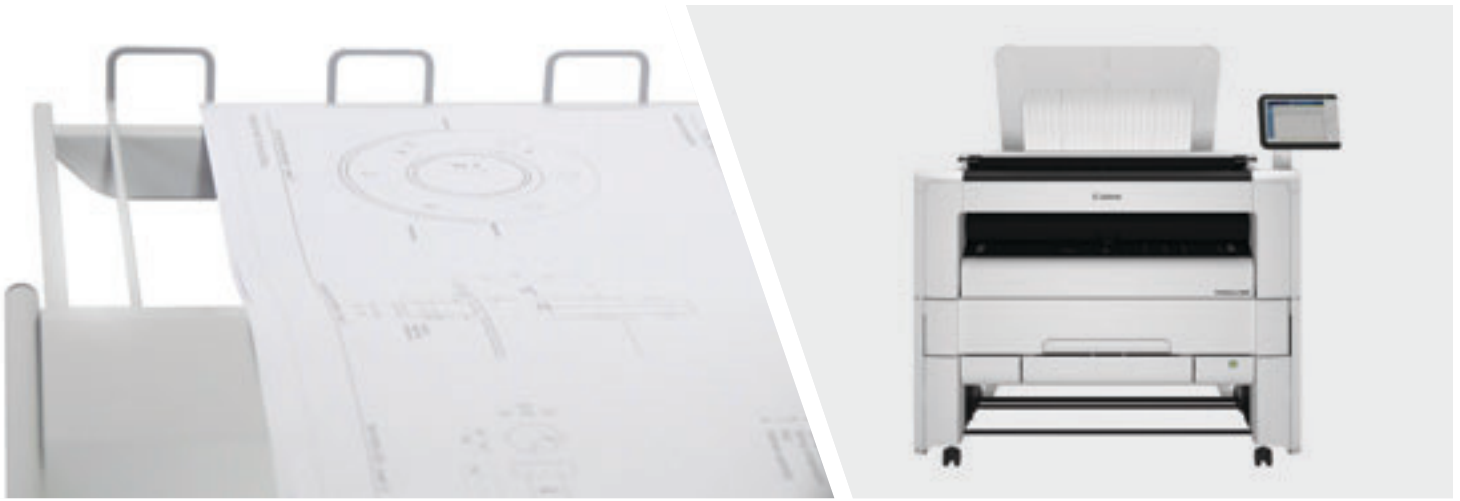

# INTELLIGENT

## PlotWave Series

### SMART FUNCTIONALITIES THAT OPTIMIZE YOUR PROCESS

The PlotWave series has intelligent automation that makes life easier in many ways. With automatic roll width detection and easy paper feeding, media loading couldn't be easier. Automatic roll switching quickly changes between media rolls and positions the image in the correct location.

Pico Printing automatically includes extra dots for impressive image quality. Radiant Fusing optimally adjusts the temperature of the system to suit the media. Radiant Fusing technology transports the paper with its toner deposit through the fusing unit, quickly emitting the optimum amount of heat.

No need to prioritize functionalities. Printing a complex job? Scan or copy documents while printing. POWERsync enables concurrent operations without sacrificing productivity or quality.

### NEAT DOCUMENT DELIVERY

The PlotWave series helps save time with its neat document delivery options. Depending on your needs, you can easily collect your prints either from the integrated Top Delivery Tray or from the optional Stacker Select. The Top Delivery Tray is positioned at an ergonomic height, and plots are neatly collated and stacked in the tray. For extra stacking capacity, choose the optional Stacker Select, which is capable of stacking up to 400, 36-inch-wide sheets.

### CONSISTENT AND HIGHLY PRODUCTIVE

With virtually no warm-up time, the PlotWave series helps save time and cuts energy costs. From sleep mode to print-in-hand in just 40 seconds. Multiple media roll options provide the ability to print a variety of jobs in-house.



### 1 FAST AND EASY WITH CLEARCONNECT PANEL

- Touchscreen with multitouch gestures for tablet/smartphone-like interaction.
- Easily control printer and scanner/copier with your fingertips using the simple screen movements.
- Swipe, spread, and zoom in on details of a drawing.
- Live Preview function to confirm documents are correctly scanned to help avoid errors.

### 2 NEAT DOCUMENT DELIVERY

- Integrated Top Delivery Tray neatly stacks and collates up to 100 E-size/A0 plots.
- Air separation technology helps prevent large documents from cascading onto the floor like conventional top stackers.
- Optional Stacker Select provides additional 400-sheet (E-size/A0) capacity.

### 3 GET BETTER COPY AND COLOR SCANNING RESULTS

- Image Logic technology automatically compensates for heavily folded/wrinkled and dark background originals to produce superior results.
- Originals are inserted face-up and width of original is detected automatically.
- Create 1-touch Scan Templates to capture commonly used settings or to require standardized departmental scan settings.

### 4 INSTANT PRODUCTIVITY WITH RADIANT FUSING TECHNOLOGY

- Get instant startup and use half the energy of comparable systems.
- Fast first printout from cold sleep to print-in-hand in less than 40 seconds.
- Helps increase productivity even more with the second roll option for multiple width rolls or longer unattended printing.

### 5 EFFORTLESS ROLL CHANGING

- Up to 650-foot roll length for maximum efficiency.
- Built-in roll loading station in each drawer.
- Media is auto-fed into the printer and roll width is auto-detected, then displayed on the ClearConnect touchscreen display.

### 6 RELIABLE QUALITY AND PERFORMANCE

- Take advantage of superb print quality with high-resolution Pico Printing at 600 x 1200 dpi.
- Award-winning industrial design with robust and durable materials.
- Extensively used areas of the printer are fabricated out of metal for commercial duty.

### 7 ECO-FRIENDLY SYSTEM

- This system has the low sound levels and heat compared to conventional fusing systems which operate on heat and pressure rollers and fans.
- Can be located and operated within workgroup environments.
- Closed toner system is easy to refill with no clumsy toner cartridges to unscrew or spill; Toner can be added while printing.

### 8 PRODUCTIVE AND SECURE POWERSYNC CONTROLLER

- Get the power to handle large and complex technical documents thanks to the productive POWERSync controller.
- Concurrency; Scan and copy while printing.
- Help protect confidential information with the latest security and protection features supported by Microsoft Windows 10 LTSC IoT Enterprise.
- The open interface of the POWERSync controller also enables the printer to embed software such as uniFLOW.

### 9 FLEXIBLE WORKFLOW

- This system is designed to make it easier to prepare, produce, and manage complex technical documents and sets of drawings.
- Advanced tools make it easy to get documents where you need them, when you need them.

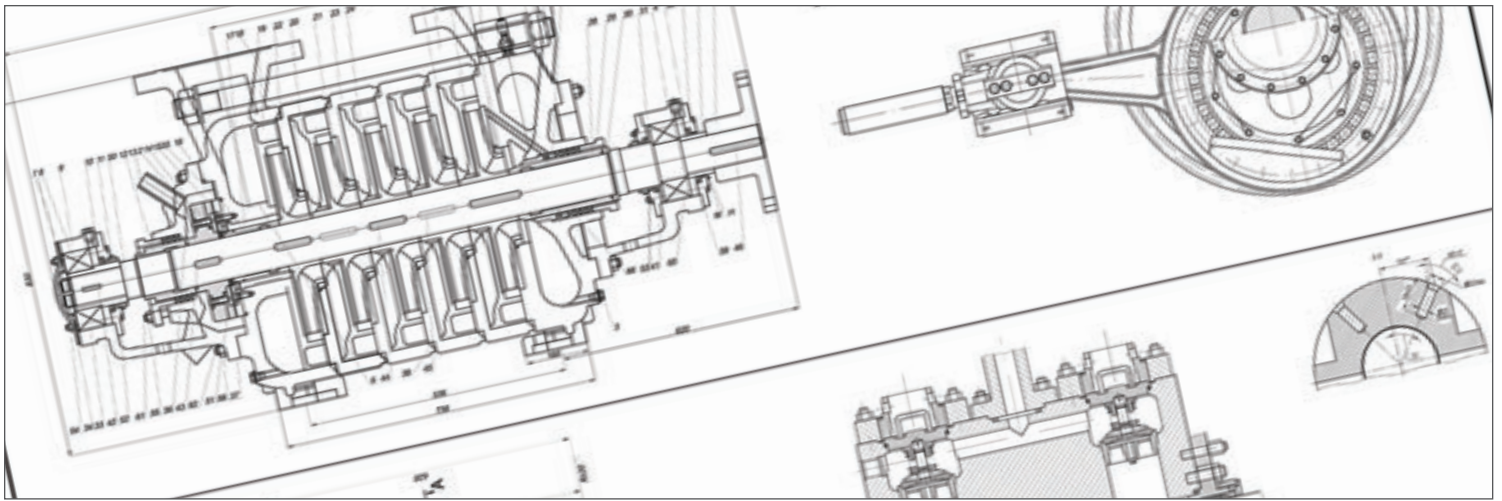

STANDARD SYSTEM CONFIGURATION		
1-roll (standard) or 2-roll printing system	Productive large format monochrome printer with ClearConnect multitouch user panel.	
Stacking system	Integrated Top Delivery Tray. Up to 100 sheets E-size/A0.	
Tilt and Swivel ClearConnect multitouch user interface	Consistent look and feel from every angle of your workflow, standard, including Smart Inbox, SmartAccess, and Live Preview.	
Roll media switching	Fully automated roll media switch to guide the media to the Top Delivery Tray or back output depending on the user application.	
ClearConnect workflow software	Drivers: Driver Select for Microsoft Windows, Driver Express PostScript 3 driver. Publishers: Publisher Mobile for IOS and Android, Publisher Express, Publisher Select 3 for Microsoft Windows.	
Starter kit included	1 bottle toner 400 g, 1 bottle developer 1750 g, 1 roll 36 inch 20 lb. bond paper (75 g/m <sup>2</sup> ).	
Earthquake provision <sup>1</sup>	Help secure the printer against moving or tilting during an earthquake. This provision enables the user to secure the printer to a sturdy connection of the building.	
OPTIONAL SYSTEM CONFIGURATIONS		
Office space saving scanning system	Scanner Express with Image Logic technology, integrated scanner positioned on top of the printer to save office space.	
Stacking systems	Stacker Select, 400-sheet capacity	
Roll media capacity upgrade	2-roll option doubles media capacity from 1,950 to 3,900 sq. ft. (182 to 365 m <sup>2</sup> ).	
Removable hard disk	For secure environments, hard disk can easily be removed from the printer system to help secure data integrity.	
TECHNOLOGY		
Imaging technology	Electrophotography (LED) with Organic photoconductor (OPC). Radiant Fusing Technology with instant warm-up. Clean toner refill system. Virtually no ozone emission.	
Fusing technology	Instant warm-up, contactless fusing, low power consumption (heating on-demand).	
Toner/type	Black toner: 800 grams per toner kit (400 grams/ bottle).	
PRODUCTIVITY		
Speed (print and copy)	PlotWave 3000: 4-D/A1-sizes <sup>2</sup> per minute 2-E/A0 sizes <sup>3</sup> per minute	PlotWave 3500: 6-D/A1-sizes <sup>2</sup> per minute 3-E/A0 sizes <sup>3</sup> per minute
First print out time <sup>4</sup>	<40 seconds	
First copy out time <sup>5</sup>	<40 seconds	

<sup>1</sup> Excluding cable/chain and mounting material.

<sup>2</sup> D-size (34" x 22") / A1 size (841 x 594 mm).

<sup>3</sup> E-size (36" x 48") / A0 Size (841 x 1189 mm).

<sup>4</sup> One A1 landscape print made from the smart inbox, on 64 g media, back output, lines, and text mode.

<sup>5</sup> One copy made with A1 original in landscape on 64 g media, back output, background compensation off, custom width 841 mm, custom length 594 mm.

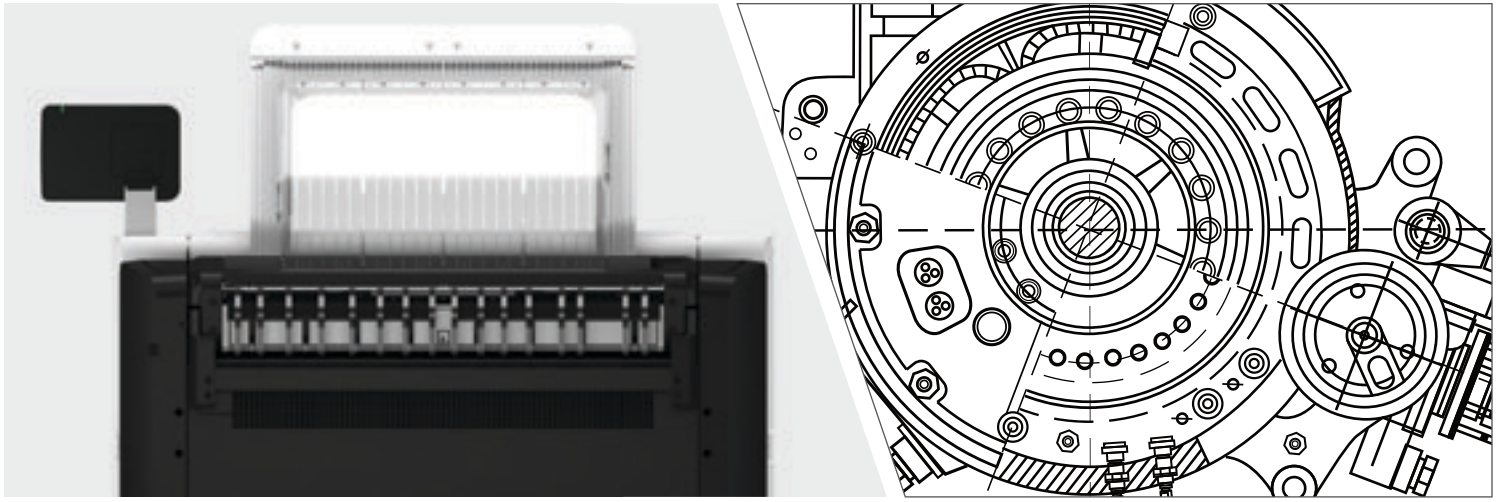

QUALITY	
Print resolution	600 x 1200 dpi
Minimum line width (ISO/IEC 13660:2001E)	0.00236" (0.06 mm)
1:1 Line accuracy	< 0.3%
SIZE AND WEIGHT	
Size main engine (WxDxH)	61.6" x 31.7" x 59.2" (1563 mm x 803 mm x 1503 mm) (Height of 59.2" includes Top Delivery Tray)
Shipping dimensions (WxDxH)	58" x 34" x 50" (1470 x 850 x 1280 mm)
Weight main engine	485 lb. (220 kg)
Shipping weight main engine	597 lb. (271 kg)
MEDIA HANDLING	
Media capacity	1 or 2 rolls; manual feed of cutsheet media
Paper cutting	Cutter included in the drawer for fast and easy roll media switching.
Maximum media capacity	1 roll (650 $\phi$ x 36" W): 1,950 sq. ft. If 2 rolls: 3,900 sq. ft.
Media sizes roll	ARCH: B, C, D, E, E1, 30", 21", 15" ANSI: B, C, D, E ISO: A3, A2, A1, A0, B1, B2, B1_700, B2_700
Media sizes Cutsheet tray	Short-edge feed (portrait): A3, B4, A, B, A+, B+, Carto B4, 230 x 310 mm, 310 x 440 mm Long-edge feed (landscape): A3, A2, B4, B3, B, C, B+, C+, Carto B4, Carto B3, 15" x 21", 310 x 440 mm, 440 x 594 mm
Media weight	Bond: 16–28 lb.(60–110g/m <sup>2</sup> ). Film: 3.5 mil.
Roll length	Up to 650 $\phi$ (200 m)
Roll width	11"–36" (11",12",15",17",18",21",22",24",30",34",36") (279-914mm)
Minimum printed length	16.5" (420 mm)
Maximum printed length	650 $\phi$ (200 m)
Roll media type	Paper: Engineering Bond, Vellum, Recycled Bond, Tinted Bond Xtreme #27 Bond Film: Polyester 3.5 mil
Cutsheet media type	Paper: Engineering Bond, Recycled Bond, Tinted Bond Xtreme #27 Bond
Automatic roll media handling	Automatic width detection Automatic roll media selection for optimized productivity and media saving, based on drawing size, media type, roll width, and finishing. Automatic roll switching when end of roll is reached.





USER INTERFACE	
Description	ClearConnect multitouch user panel
Size (WxDxH)	11.8" x 8.7" x 1.6" (300 x 220 x 40 mm), 10.4" (diag.) color LCD
Resolution	800 x 600 pixels (SVGA)
Technology	Projective capacitive touch
Operation	3 hard buttons: [Wake-up], [Stop, interrupt, abort], [Home] Multitouch functions: tap, double tap, pinch, 2-finger pinch, swipe, flick, and spread.
Interface design	Distinctive user interface with intuitive navigation and clearly defined levels of operation.
Features	View optimization: Tilt ClearConnect (-4 to +45 degrees) and swivel (-45 to +180 degrees). Status light (red, orange, green). USB 2.0 interface with indication light. Switch instantly between 2 languages, select from 21 languages.
CONTROLLER	
Description	High performance POWERsync controller with Windows 10 IoT Enterprise LTSC, 64-bit
Processor	Dual Core, Dual Thread Celeron® G4900 at 3.10GHz
Memory	4 GB DDR4
Video	Intel HD Graphics, 1GHz
Hard disk	500 GB, 7200 rpm (standard)
TPM	TPM2.0
Client operating system support	Windows 7 / Windows 7 64 bits / Windows 8.1 / Windows 8.1 64 bits / Windows 10 / Windows 10 64 bits / Windows Server 2008 R2 64 bits / Windows Server 2012 64 bits / Windows Server 2012 R2 64 bits / Mac OS 10.10 / Mac OS 10.11 / Mac OS 10.12 (PostScript 3 driver support only for Mac OS )
Interface	2x Ethernet 100 Mbits/s, 1Gbit/s TCP/IP: DHCP, IPv4, IPv6, HTTPS Discovery: APIPA, WS-Discovery, SNMPv3
Page description language	TIFF, JPEG, HPGI, HPGI2, DWF, C4, Calcomp 906/907/951, CALS, NIRS, NIFF, PS/PDF (optional)
Printing protocol	LPR, FTP, WebDav, WSD print FTP Pull from SMB, FTP Pull from cloud (retrieve from WebDAV based clouds) HTTP/HTTPS (used by Publisher Express) Print from home folder via optional access management
Backchannel protocol	SNMPv3, Wave interface, WS-Discovery



SECURITY	
Security Features	E-shredding, IPSec, IP filtering/Access Control Lists, HTTPS, SNMPv3, audit logging, AES256 Disk Encryption, 802.1x Authentication, network protocol enable/disable, LDAP integration, Active Directory Integration, User authentication on local ClearConnect user panel and via Express WebTools (LDAP/Active Directory credentials, smart card) for scan/copy/print. Configure HTTPS Certificates. Allow disabling TLS1.0 and 1.1 protocols (no response to network scan) and enable TLS 1.2 with stronger cipher. Embedded FIPS 140-2 Certified Trusted Platform Module (TPM) and BitLocker 256 AES hard disk encryption, hard disk wipe, Configurable CA certificate, Disable Network Ports and Protocols, Security Event Logging, Single Sign-on. Options: Removable hard disk, McAfee antivirus, McAfee Application control (whitelisting).
Access management	Help provide secure access to device by users keying in password on the ClearConnect multitouch operator panel or get access with a Smart Card by connecting a card reader (including contactless). Authorization is managed by using Active Directory.
Cloud support	Unlimited user and/or Administrator authenticated cloud support via WebDAV and/or third-party provider: e.g. Microsoft SharePoint, Dropbox, Box.com, box.net, Google Drive, Microsoft OneDrive, Amazon Cloud Drive, Cloudsafe, MyDisk. The cloud user authentication can either be preconfigured by the administrator or done by the user at the time of accessing the specific cloud.
Transformations	Scaling (scale-to-fit page, reduce when image too large to avoid clipping or to custom factor, scale page size to standard size), Rotation, Shift (automatic or user defined), Adding/removing trailing/leading edge, Mirror, Black intensity in poster mode, Print optimization (standard, lines/text, poster). Color Highlight and Dark Original. Area to erase (area of interest).
SCANNER EXPRESS (OPTIONAL)	
Description	Integrated Contact Image Sensor (CIS) Color scanner with Image Logic technology
Scan resolution	600 x 600 dpi
Scan speed	Up to 49.8 ft./min. (15.2 m/min.) Black & white scanning Up to 33.1 ft./min. (10.1 m/min.) Copying Up to 16.4 ft./min. (5.0 m/min.) Color scanning
Scan formats	TIFF, PDF, PDF/A, JPEG, CALS, multipage PDF, multipage PDF/A and multipage TIFF
Scan templates	Extensive number of scan templates to standardize common scan settings and destinations
Scan protocol	FTP, SMB, scan to cloud (push to WebDAV based clouds)
Scan destination	Local USB flash drive, FTP, SMB, Smart Inbox on Controller, Optional Local Home folder (LDAP), mobile device via Mobile WebTools, WebDAV Clouds.
Scan naming	Preset naming with auto numbering for productive scanning or file name on the ClearConnect user panel
Original width	8.2"-36" (208-914 mm), automatic width detection
Original length	8.2"-52.5" (208 mm-16 m), auto length detection
Original thickness	Maximum 0.03" (0.8 mm) non-rigid documents
Zoom (copy)	1:1, Scale to media size, Scale to standard format. Custom: 10-1,000%
Original type presets	Lines & Text standard, Folded Lines & Text, Lines & Text draft, Dark Original, Colored Original, Photo, Blueprint, Map, Artwork
Scanner size (WxDx H)	43" x 12" x 5.5" (1,097 x 308 x 140 mm)
Scanner weight	55 lb. (25 kg)

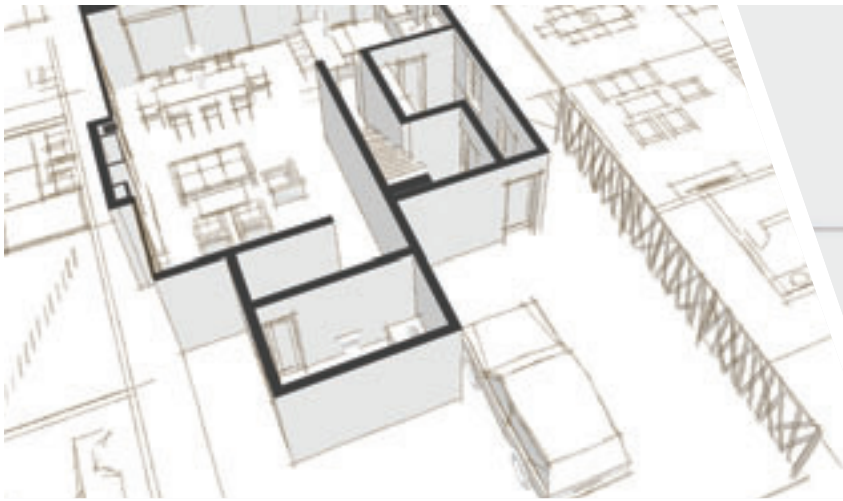

ENVIRONMENTAL	
Acoustic sound power	Standby and sleep: less than 26 dB. Print mode: less than 52 dB
Ozone concentration	<0.001 mg/m <sup>3</sup> , <0.000473 PPM (0.05% of permitted limit value)
Heat emission	Ready: 66 W; Active: 1.5 kW
Power requirements	100–240 V; 50/60Hz
Power consumption	Sleep mode: <2 W Ready mode: 66 W Active mode: 1.5 kW
Safety/EMC marks and environmental labels	CE, TUV GS, CETECOM, Energy Star 3.0, FEMP, Rohs, CCC, VCCI TüV GS, c-UL-US, CB, RCM, EPEAT, EAC, FCC Class A, VCCI Class A
Recyclables	Printer: made of steel or highly recyclable plastics: up to 95% of the engine can either be upcycled or recycled. Remaining 5% are nontoxic waste. Prints: very good deinkability when recycled. Toner: bottles made of highly recyclable HDPE (High Density Polyethylene)
CLEARCONNECT WORKFLOW SOFTWARE	
Job submission	The ClearConnect software suite consists of a variety of applications with the same user interface. Create, retrieve, and/or send jobs from drivers (Driver select for Microsoft Windows, Driver Express for Adobe PostScript 3 for Microsoft Windows or Apple OS), external locations (SMB, FTP, LPR, WebDAV), Mobile devices via Express WebTools and Publisher Mobile, USB flash drive, Cloud services, and optional Home folder (LDAP). 1-click printing from USB, 1-click printing from previous sent jobs via Print SmartAccess on ClearConnect user panel. The Smart Inbox on the ClearConnect user panel enables the job preview: swipe between your jobs for print selection and preview. Pan to view the image in detail (zoom). With the template-oriented Publisher Select 3 submitting multiple files in batches is supported. Print multiple times and sort by page or set. Media saving automatically rotates print files to optimize media usage.
Smart inbox	Personalized Smart Inbox: History, Manage Queue, Manage History, Express WebTools, Secured Controller Access
Queue management	Spool memory provides a queuing system for print and copy jobs. This enables multiple users to send print and copy jobs at the same time. Customize priority settings for copy and print jobs in the queue. The Job Queue overview gives access to job names, owners, and status including required media. Jobs can be paused, deleted, and placed on top of the queue.
Print management and accounting	View the counter history at preferred time periods, per job or total overview in Express WebTools. View, create, edit, and delete stamp templates. Optional uniFLOW support, log in with your personal uniFLOW Queue on the ClearConnect User interface. Supports manual authentication, card readers, and contactless card readers.
Device management	Express WebTools provide administrators the tools to manage the device remotely via the web: e.g. check printer status; define settings for print, copy, and scan; define access; security; accounting; remote shutdown; software update and restart; power on/off timer; system behavior; queue management; license management; view, create, edit, and delete stamp templates; etc.
Scan to color inkjet	Scan directly to iPF 600/700/800/TX- 2000/3000/4000/5200/5300/5400 series via Publisher Select 3 (hotfolder)
STACKER SELECT	
Description	Integrated productive stacker with high capacity and tray full sensor
Capacity	400 pages

# WHY CANON SOLUTIONS AMERICA

Canon Solutions America recommends forward-thinking strategies to help achieve the highest levels of information management efficiency for your unique business needs. Using superior technology and innovative services, we then design, implement, and track solutions that help improve information flow throughout your organization while considering the environment, which can aid in greater productivity and reduced costs.

There are many reasons why you should choose Canon Solutions America as your provider for document management solutions. Benefits include:

- A Canon U.S.A. Company
- Business Services
- Professional Services
- Global Monitoring Capabilities
- Certified Training and Support
- Flexible Finance Options
- Single-Source Solutions Provider
- Managed Document Services
- Nationwide Coverage
- Customized Industry Solutions
- Genuine Canon Parts and Supplies
- Diverse Range of Input-to-Output Technology

But that's not all. As a company that is dedicated to your needs, we support our solutions with highly skilled professionals and advanced diagnostic systems to help maintain peak performance. And with ongoing consultation, we can further your document management capabilities to help ensure the highest level of satisfaction and productivity.



CANON SOLUTIONS AMERICA

**Large Format Solutions**

100 Park Blvd., Itasca, IL 60143

1-800-842-4534 | 1-630-250-6551

[us.info@csa.canon.com](mailto:us.info@csa.canon.com) [CSA.CANON.COM](http://CSA.CANON.COM)

Canon Solutions America does not provide legal counsel or regulatory compliance consultancy, including without limitation, regarding Sarbanes-Oxley, HIPAA, CCPA, GDPR, GLBA, Check 21, or the USA Patriot Act. Each customer must have its own qualified counsel determine the advisability of a particular solution as it relates to regulatory and statutory compliance. Canon products offer certain security features, yet many variables can impact the security of your devices and data. Canon does not warrant that use of its features will prevent security issues. Some security features may impact functionality/performance; you may want to test these settings in your environment.

Canon is a registered trademark of Canon Inc. in the United States and elsewhere. PlotWave, Publisher, Publisher Mobile, Publisher Express, ClearConnect, and Image Logic are trademarks or registered trademarks of Canon Production Printing Netherlands B.V. All other referenced product names and marks are trademarks of their respective owners and are hereby acknowledged. Illustrations and printer output images are simulated.

© 2020 Canon Solutions America, Inc. All rights reserved.

9/20-0820-4889

LFS-51458 DS 9/11/20 CC/PDF